

ROHS
Compatible

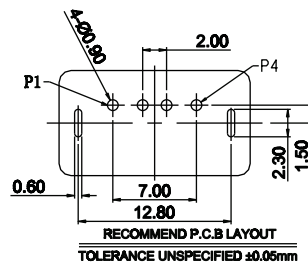
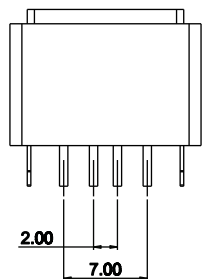
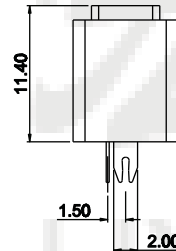
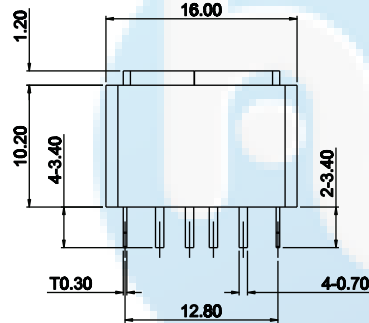
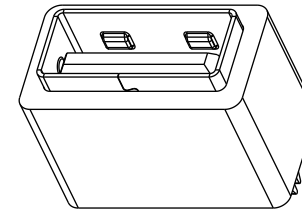
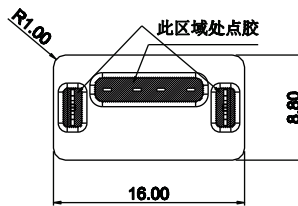
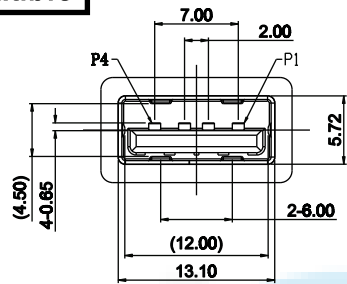

NETOS:

一.电气特性:Electrical:

- 1.额定电流 : Current Rating : 1.5A/contact terminal.
- 2.额定电压 : Voltage Rating: 30V DC.
- 3.接触阻抗:Contact Resistance: 30 milliohms MAX.
- 4.耐电压:Dielectric Withstanding Voitage: 100 V AC AT Sea Level.
- 5.绝缘阻抗:Insulation Resistance: 1000 MΩ Min.

二.物理性能:Mechanical:

- 1.插拔力 : Cnector Mate and Unmate Force :
Mate force:3.57kgf(MAX).
Unmate force:1.02kgf(MIN) .

三.原材料:Matorial:

- 1.塑胶:Housing: HIGH-TEMPERATURE PLASTIC. BLACK, UL 94 V-0.
- 2.端子: COPPER ALLOY, T0.25mm.
- 3.外壳: STAINLESS STEEL.T0.30mm.
- 4.护套: HIGH-TEMPERATURE PLASTIC. BLACK,UL94V-0.
- 5.防水圈 : 硅胶 60D. 黑色.
- 6.防尘塞 : HIGH-TEMPERATURE PLASTIC. BLACK, UL 94 V-0.

四.电镀:Finish:

- 1.端子: PLATED GOLD IN MATING AREA.
TIN ON SOLDER TALLS.
BOTTOM PLATING NICKEL.
- 2.外壳: NICKEL PLATING.

五.盐雾 : 24H.

U2 033- 04P x 11.4L x
↓ ↓ ↓ ↓ ↓ ↓
名称 流水号 PIN位 Y;鱼插脚 L;长度 F;防水

PIN ASSIGNMENT:

PIN NO.	1	2	3	4
SINGAL NAME	VBUS	D-	D+	GND

DESIGN	Li Jinwei	SC ALL		 TOLERANCE X.X ±0.30 X.°±2° .XX ±0.20 .X°±1° .XXX ±0.10 .XX°±0.5°	DRAWG NO.	U2033-04PY11.4LF
DRAWING	Wu Qifa	UNIT	mm		TITLE:	防水USBAF2.0 立式两脚插板DIP 鱼插脚 11.4L
CHECK	Zheng Jinxian	SIZE	A4: 210 * 297			
APPROVAL	Liu Xiaohong	DATE	2020-06-10			

东莞市宏煜盛实业有限公司
Dongguan hongyusheng Industry Co., Ltd
TEL: 0769-81230179 <https://www.hystypec.com>