

ROHS
Compatible

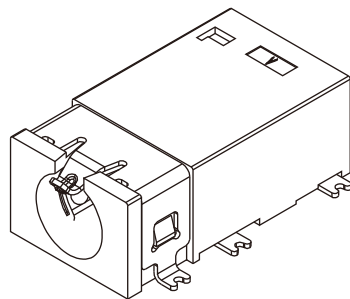

3D VIEW

- CONTACT CURRENT RATING: 1A.
- CONTACT RESISTANCE: 50 mΩ MAX.;
- INSULATION RESISTANCE: 100MΩ MIN.;
- DIELECTRIC WITHSTANDING: 500V AC MIN.;
- DURABILITY: 5,000 CYCLES MIN.;
- CONNECTOR MATING FORCES: 29.4N MAX.;
- CONNECTOR UNMATING FORCES: 2.94N MIN.;

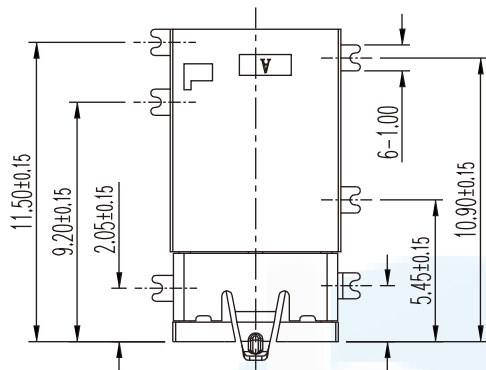
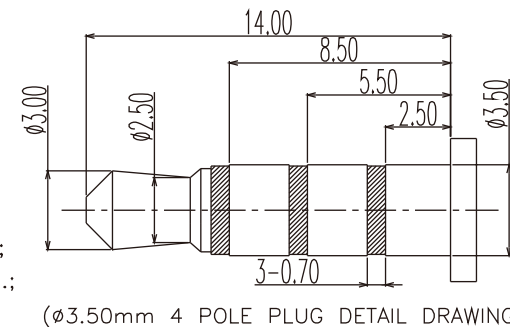

(ø3.50mm 4 POLE PLUG DETAIL DRAWING)

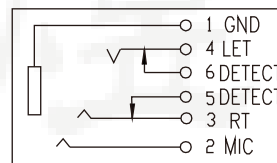
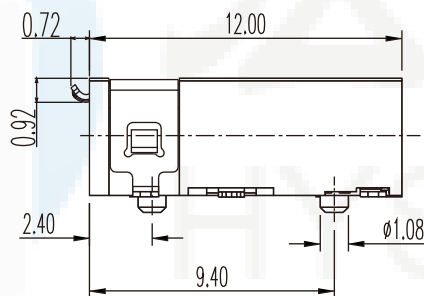
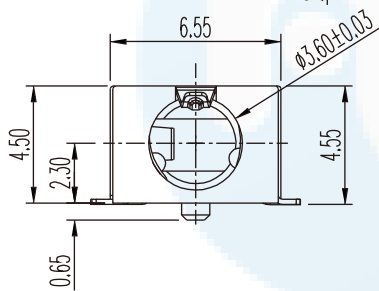

SCHEMATIC

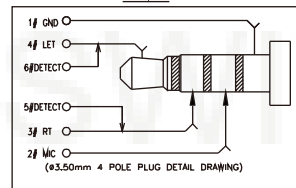

(ø3.50mm 4 POLE PLUG DETAIL DRAWING)

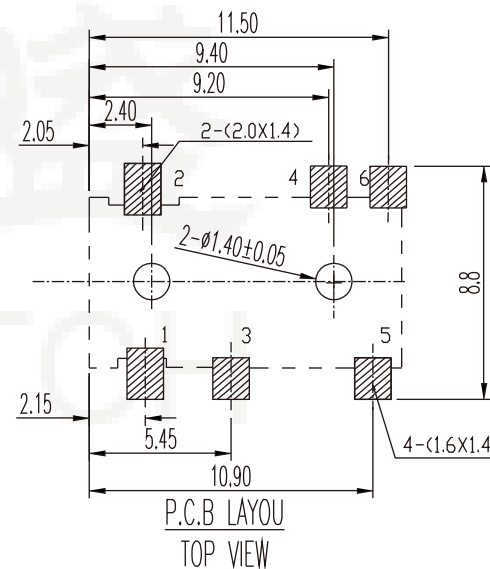

P.C.B LAYOUT
TOP VIEW

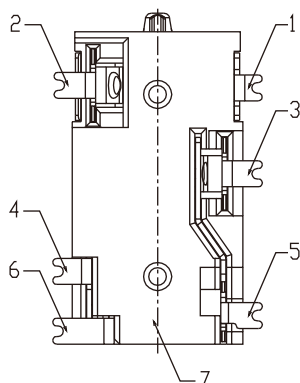

7	HOUSING	1	HIGHT TEMPERATURE PLASTIC COLOR BLACK	
6	TERMINAL 6#	1	BRASS; NICKEL UNDER PLATING OVERALL,GOLD FLASH PLATING ON SOLDER AREA	T=0.20mm
5	TERMINAL 5#	1	BRASS; NICKEL UNDER PLATING OVERALL,GOLD FLASH PLATING ON SOLDER AREA	T=0.20mm
4	TERMINAL 4#	1	STAIMLESS STEEL; NICKEL UNDER PLATING OVERALL,GOLD FLASH PLATING ON SOLDER AREA ;GOLD FLASH PLATING ON CONTACT AREA	T=0.20mm
3	TERMINAL 3#	1	PHOSPHOR BRONZE; NICKEL UNDER PLATING OVERALL,GOLD FLASH PLATING ON SOLDER AREA ;GOLD FLASH PLATING ON CONTACT AREA	T=0.20mm
2	TERMINAL 2#	1	PHOSPHOR BRONZE; NICKEL UNDER PLATING OVERALL,GOLD FLASH PLATING OVERALL;	T=0.20mm
1	TERMINAL 1#	1	PHOSPHOR BRONZE; NICKEL UNDER PLATING OVERALL,GOLD FLASH PLATING OVERALL;	T=0.20mm
ITEM	NAMF	Q'TY	DESCRIPTION	NOTF

DESIGN	Li Jinwei	SC ALL	
DRAWING	Wu Qifa	UNIT	mm
CHECK	Zheng Jinxian	SIZE	A4: 210 * 297
APPROVAL	Liu Xiaohong	DATE	2020-06-10

TOLERANCE	
X.X ±0.30	X.°±2°
.XX ±0.20	.X°±1°
.XXX ±0.10	.XX°±0.5°

DRAWG NO.	PJ-413
TITLE:	ø3.5mm 耳机插座

 **东莞市宏煜盛实业有限公司**
Dongguan hongyusheng Industry Co., Ltd
TEL: 0769-81230179 <https://www.hystypec.com>