

**ROHS**  
Compatible

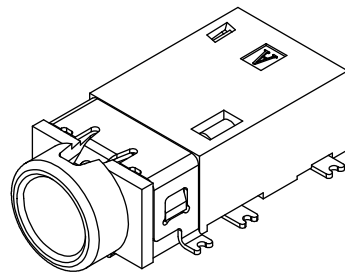

3D VIEW

- CONTACT CURRENT RATING: 1A.
- CONTACT RESISTANCE: 50 mΩ MAX.;
- INSULATION RESISTANCE: 100MΩ MIN.;
- DIELECTRIC WITHSTANDING: 500V AC MIN.;
- DURABILITY: 5,000 CYCLES MIN.;
- CONNECTOR MATING FORCES: 30N MAX.;
- CONNECTOR UNMATING FORCES: 3N MIN.;

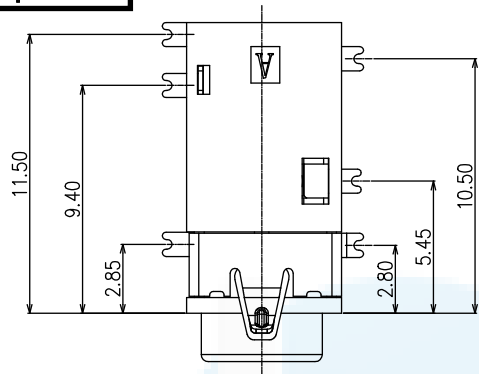
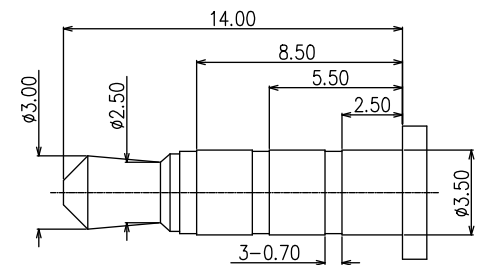

(ø3.50mm 4 POLE PLUG DETAIL DRAWING)

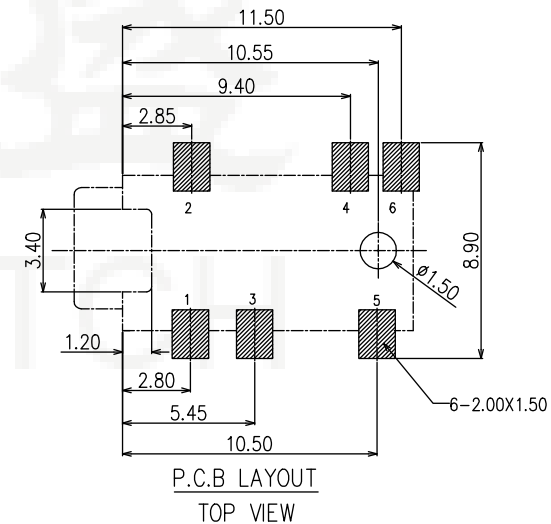
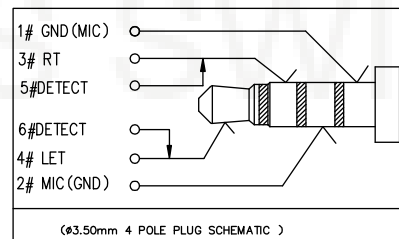
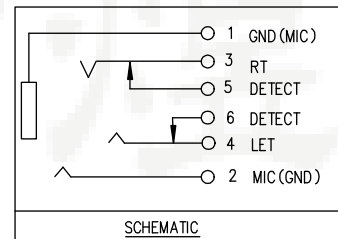
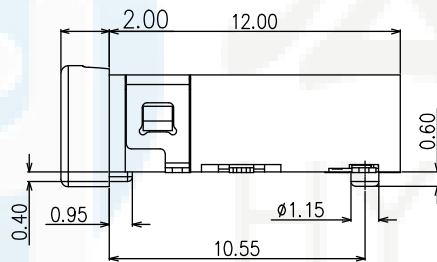
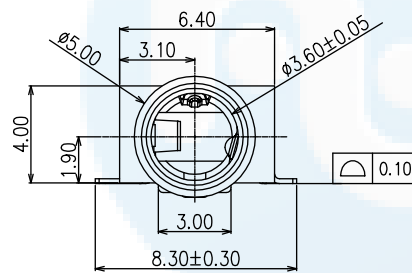

P.C.B LAYOUT  
TOP VIEW

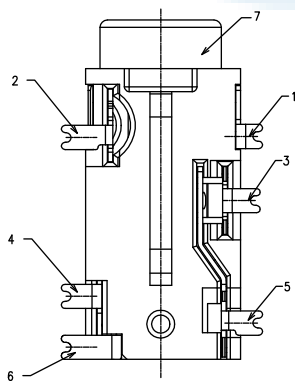

ITEM	NAME	Q'TY	DESCRIPTION	NOTE
7	HOUSING	1	HIGHT TEMPERATURE PLASTIC COLOR BLACK	
6	TERMINAL 6#	1	COPPER ALLOY; NICKEL UNDER PLATING OVERALL,GOLD PLATING ON SOLDER AREA ;GOLD PLATING ON CONTACT AREA	T=0.20mm
5	TERMINAL 5#	1	COPPER ALLOY; NICKEL UNDER PLATING OVERALL,GOLD PLATING ON SOLDER AREA ;GOLD PLATING ON CONTACT AREA	T=0.20mm
4	TERMINAL 4#	1	COPPER ALLOY; NICKEL UNDER PLATING OVERALL,GOLD PLATING ON SOLDER AREA ;GOLD PLATING ON CONTACT AREA	T=0.20mm
3	TERMINAL 3#	1	COPPER ALLOY; NICKEL UNDER PLATING OVERALL,GOLD PLATING ON SOLDER AREA ;GOLD PLATING ON CONTACT AREA	T=0.20mm
2	TERMINAL 2#	1	COPPER ALLOY; NICKEL UNDER PLATING OVERALL,GOLD PLATING ON SOLDER AREA ;GOLD PLATING ON CONTACT AREA	T=0.20mm
1	TERMINAL 1#	1	COPPER ALLOY; THE BOTTOM OF THE NICKEL; THE WHOLE GOLD PLATING.	T=0.20mm

DESIGN	Li Jinwei	SCALL	
DRAWING	Wu Qifa	UNIT	mm
CHECK	Zheng Jinxian	SIZE	A4: 210 * 297
APPROVAL	Liu Xiaohong	DATE	2020-06-10

TOLERANCE	
X.X ±0.30	X.°±2°
.XX ±0.20	.X°±1°
.XXX ±0.10	.XX°±0.5°

DRAWG NO.	PJ-410
TITLE:	Φ3.5mm 耳机插座

**东莞市宏煜盛实业有限公司**  
 Dongguan hongyusheng Industry Co., Ltd  
 TEL: 0769-81230179 <https://www.hystypec.com>