

**ROHS**  
Compatible

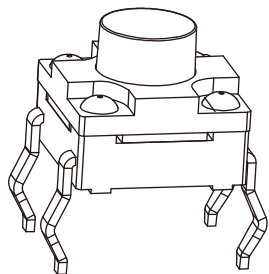

H	
4.3	4.5
5.0	5.5
6.0	5.5
7.0	7.5
8.0	8.5
9.0	9.5

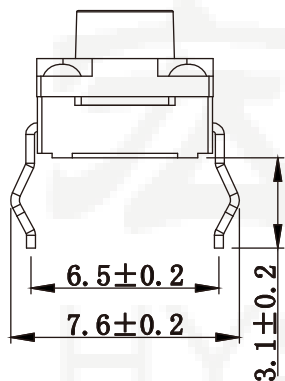
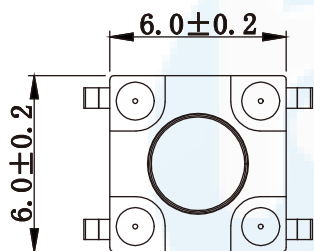
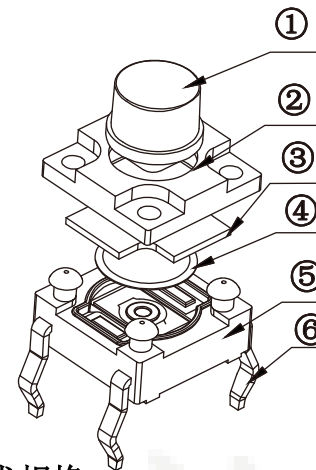
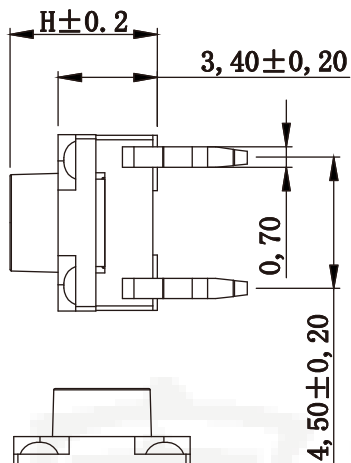

主要技术规格:

1. 额定值: 50mA DC12V
2. 接触电阻:  $\leq 50\text{m}\Omega$
3. 操作力:  $160 \pm 40\text{gf} & 250 \pm 40\text{gf}$
4. 行程:  $0.3 \pm 0.1\text{mm}$
5. 绝缘电阻:  $\geq 100\text{M}\Omega$
6. 抗电强度: 250V 50HZ 1Min.
7. 寿命: 100,000 Cycles
8. 防水等级: IP67
9. 防银迁移: 60V, 85°C, 90%RH/60H

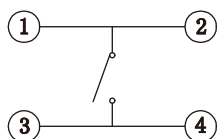

电路图

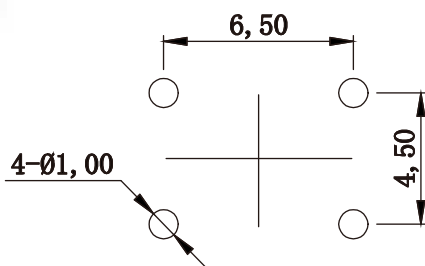

PCB. 焊接图

序号	部件名称	材料	备注
1	按钮	PPA	耐温280°C (黑色)
2	盖板	PPA	耐温280°C (黑色)
3	防水垫	硅胶	耐温280°C (黑色)
4	簧片	不锈钢	覆银
5	基座	PPA	耐温280°C (黑色)
6	引脚、触点	黄铜	镀银

DESIGN	Li Jinwei	SCALL		 TOLERANCE .XX ±0.30 X.°±2° .XX ±0.20 .X.°±1° .XXX ±0.10 .XX°±0.5°
DRAWING	Wu Qifa	UNIT	mm	
CHECK	Zheng Jinxian	SIZE	A4: 210 * 297	
APPROVAL	Liu Xiaohong	DATE	2020-06-10	

DRAWG NO. HYS-1141F  
TITLE: 防水轻触开关插件 6\*6\*H



**东莞市宏煜盛实业有限公司**  
Dongguan hongyusheng Industry Co., Ltd  
TEL: 0769-81230179 <https://www.hystypec.com>