

ROHS
Compatible

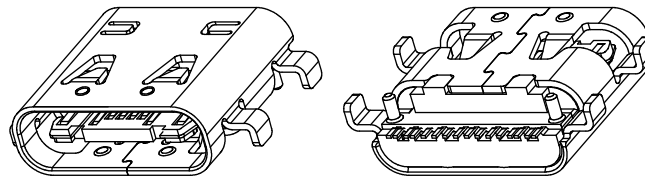
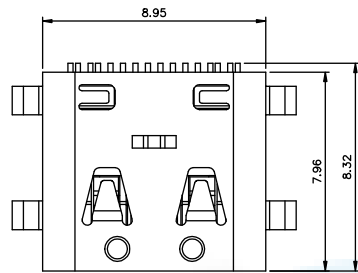

NOTES:

1.MATERIAL:

MOLDING: LCP UL94 V-0

CONTACT: COPPER ALLOY.

GOLD PLATED Min ON CONTACT AREA, 100u"

Min TIN (LEAD FREE) ON SOLDER AREA,

SHELL: SUS304-H,T=0.30±0.03mm

50u" NICKEL PLATING OVER ALL.

SHILD: SUS304-H,T=0.12±0.03mm

2.MECHANICAL:

INSERTION: 5~20N.

EXTRACTION: 8~20N AFTER TEST.

DURABILITY: 10000 CYCLES

3.ELECTRICAL:

CURRENT: 5A FOR VBUS;

1.25A FOR GND PIN.

0.25A FOR OTHER.

VOLTAGE: 20 V MAX

WITHSTANDING VOLTAGE: 100V AC R.M.S.

CONTACT RESISTANCE: 40mΩ MAX.

INSULATION RESISTANCE: 100MΩ MIN.

4.ENVIRONMENTAL

TEMPERATURE RANGE -25°C ~ +85°C

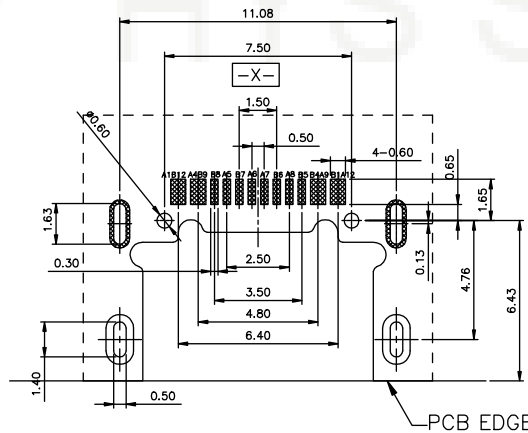
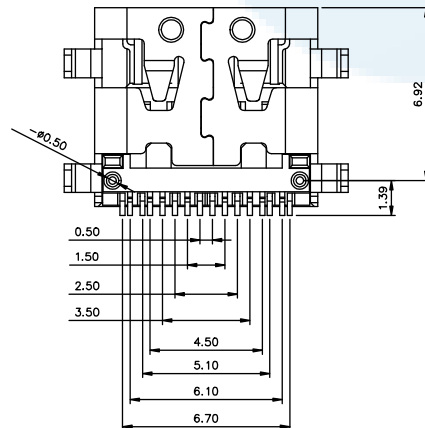
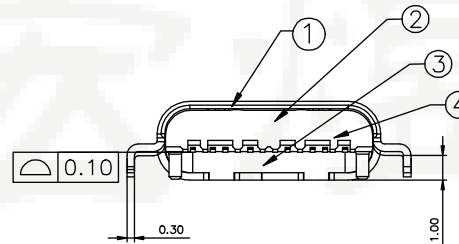
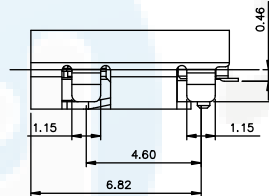
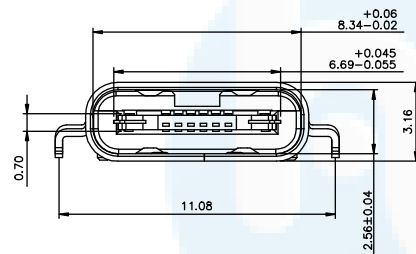

A1	GND	B12	GND
A4	VBUS	B9	VBUS
A5	CC1	B8	SBU2
A6	DP1	B7	DN2
A7	DN1	B6	DP2
A8	SBU1	B5	CC2
A9	VBUS	B4	VBUS
A12	GND	B1	GND
PIN	SIGNAL NAME	PIN	SIGNAL NAME

DESIGN	Li Jinwei	SCALL	
DRAWING	Wu Qifa	UNIT	mm
CHECK	Zheng Jinxian	SIZE	A4: 210 * 297
APPROVAL	Liu Xiaohong	DATE	2020-06-10

TOLERANCE	
X.X ±0.30	X.°±2°
.XX ±0.20	.X°±1°
.XXX ±0.10	.XX°±0.5°

DRAWG NO.	TYPE-C-CDST16PZ100
TITLE:	16P 沉板1.0四脚插板SMT带弹 7.96L



东莞市宏煜盛实业有限公司
Dongguan hongyusheng Industry Co., Ltd
TEL: 0769-81230179 <https://www.hystypec.com>