

ROHS
Compatible

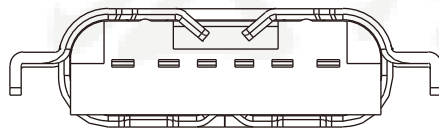
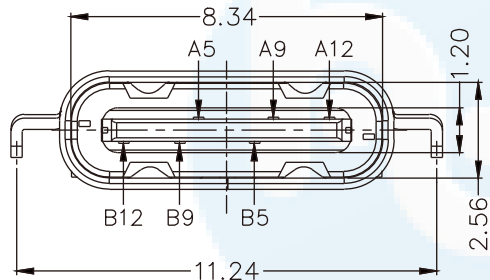
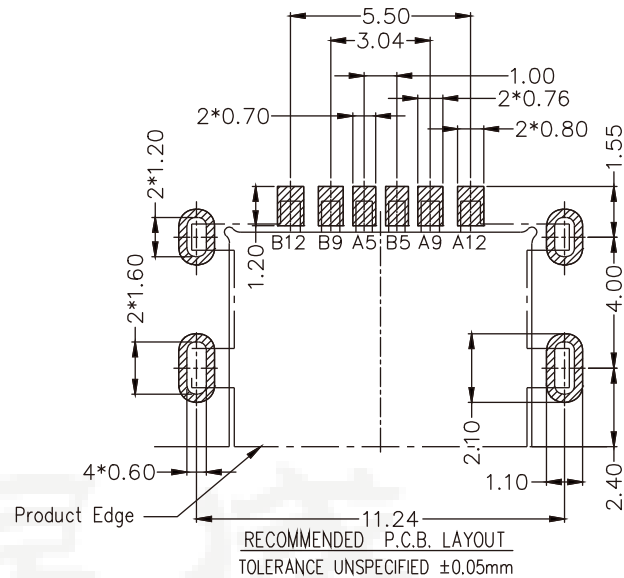
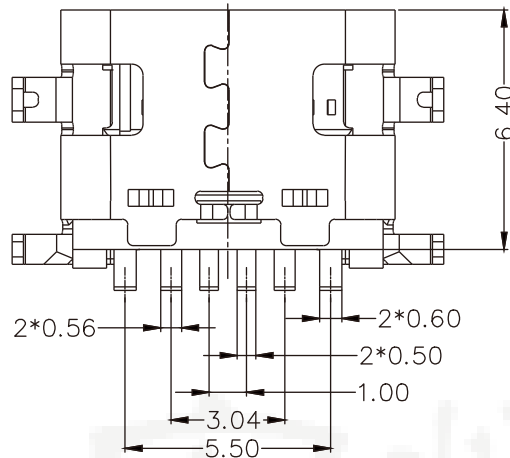
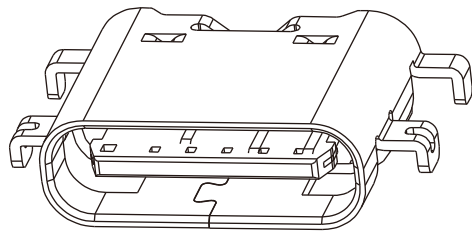

NOTES:

SPECIFICATION:

1. CURRENT RATING: 3.0A MAX
2. VOLTAGE: 100 VAC
3. TEMPERATURE RANGE: -30 °C ~ 85 °C
4. CONTACT RESISTANCE: 40 MILLIONHM MAX
5. INSULATION RESISTANCE: 100 MEGOHMS MIN.
6. INSERTION FORCE : 5N~20N
7. UNMATING FORCE: 8N~20N
8. DURABILITY: 10000 CYCLES

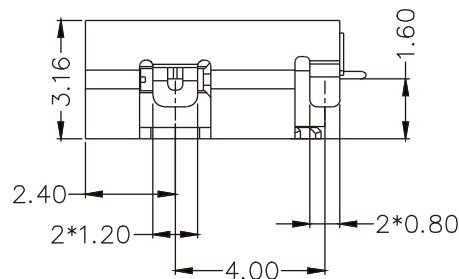
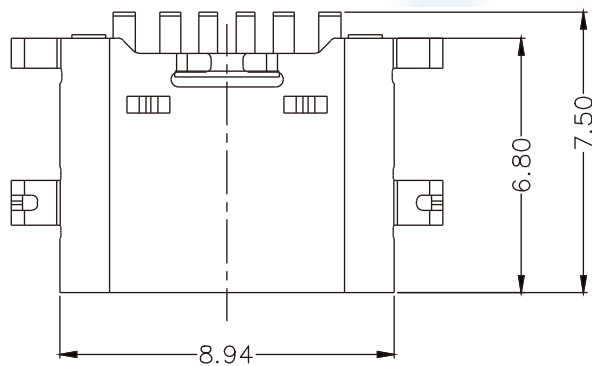

A5	CC1	B12	GND
A9	VBUS	B9	VBUS
A12	GND	B5	CC2
PIN	SIGNAL NAME	PIN	SIGNAL NAME

3	SHELL	STAINLESS STEEL	Ni: 50u" Plated	1SET
2	CONTACT	COPPER ALLOY	Au1u"/Ni: 50u" Plated	1SET
1	HOUSING	HIGH TEMPERATURE PLASTIC	BLACK	1PCS
NO.	DESCRIPTION	MATERIAL	REMARKS	QTY

DESIGN	Li Jinwei	SCALL		 TOLERANCE .XX ±0.30 X.* ± 2. .XX ±0.20 X.* ± 1. .XXX ±0.10 .XX* ±0.5.
DRAWING	Wu Qifa	UNIT	mm	
CHECK	Zheng Jinxian	SIZE	A4: 210 * 297	
APPROVAL	Liu Xiaohong	DATE	2020-06-10	

DRAWG NO.	TYPE-C-DSC06P160
TITLE:	单排6P沉板1.6四脚插板



东莞市宏煜盛实业有限公司
Dongguan hongyusheng Industry Co., Ltd
TEL: 0769-81230179 <https://www.hystypec.com>