

ROHS
Compatible

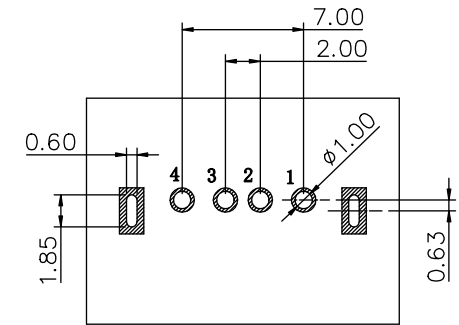

RECOMMENDED PCB LAYOUT (TOP VIEW)
DEFAULT TOLERANCE+/-0.05
THICKNESS T=1.6mm

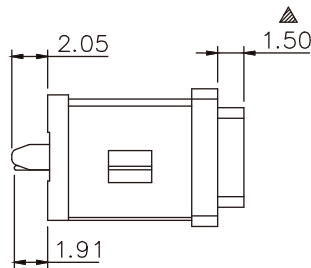
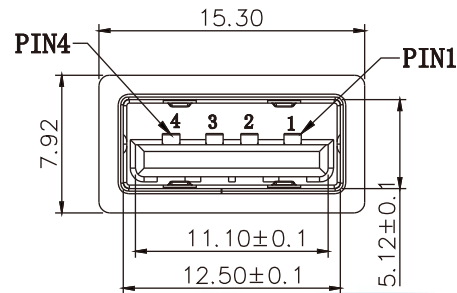
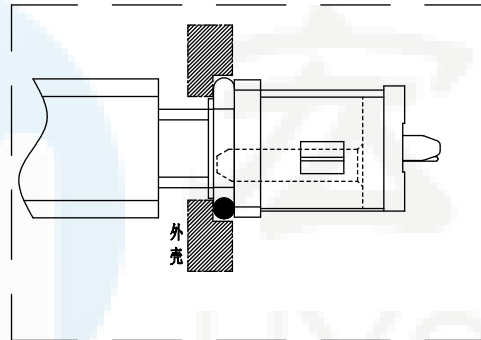
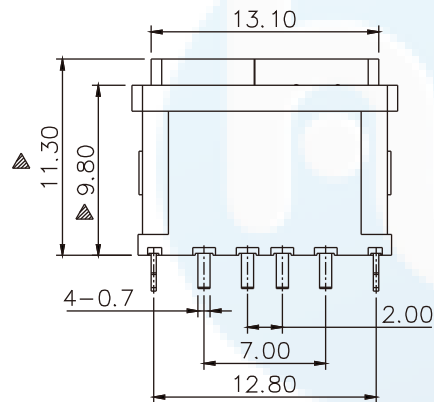

PIN ASSIGNMENT

PIN NO.	1	2	3	4
SINGAL NAME	VBUS	D-	D+	GND

NOTES:

SPECIFICATION:

1. CURRENT RATING: 3.0A MAX
2. DIELECTRIC WITHSTAND VOLTAGE: 100VAC
3. TEMPERATURE RANGE: -30 °C ~ 85 °C
4. CONTACT RESISTANCE: 40 MILLIONHM MAX
5. INSULATION RESISTANCE: 100 MEGOHMS MIN.
6. INSERTION FORCE :8N~35N
7. UNMATING FORCE: 8N~35N
8. DURABILITY:1500 CYCLES

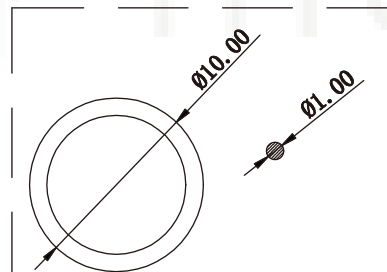
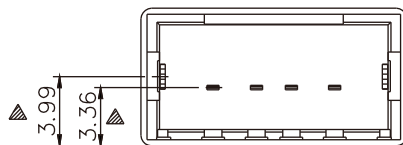

注：防水圈是圆形截面，直径为1.0mm的
硅胶圈，防水圈挤压力，由1.0mm挤压到
0.4mm ~ 0.5mm，防水效果好

3	Shell	1	SUS 301 1/4H
3	PLASTIC Shell	1	PA9T&LCP (G.F30%)
2	Contact	4	BRASS C2680-EH Au/Ni Plating T=0.25mm
1	Housing	1	PA10T (G.F30%)
TQM	PAPT NAMF	O'TV	FINISII

DESIGN	Li Jinwei	SCALL	
DRAWING	Wu Qifa	UNIT	mm
CHECK	Zheng Jinxian	SIZE	A4: 210 * 297
APPROVAL	Liu Xiaohong	DATE	2020-06-10

TOLERANCE	
X.X ±0.30	X.°±2°
.XX ±0.20	.X°±1°
.XXX ±0.10	.XX°±0.5°

DRAWG NO:	USB-U-LD73F
TITLE:	立式插脚 配防水圈 IPX8



东莞市宏煜盛实业有限公司
Dongguan hongyusheng Industry Co., Ltd
TEL: 0769-81230179 <https://www.hystypec.com>