

ROHS
Compatible

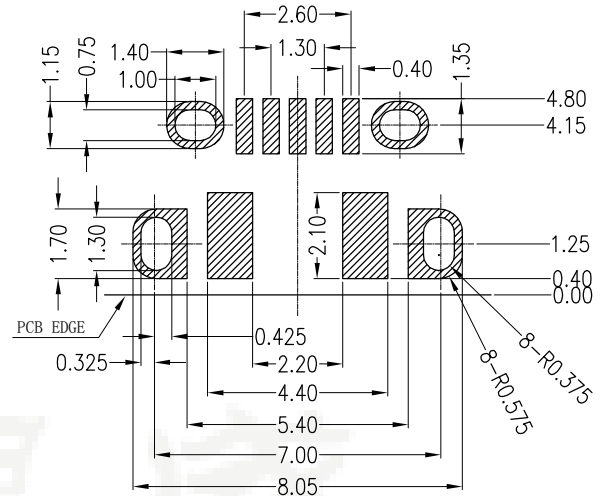

PCB图仅做参考
RECOMMEND PCB LAYOUT

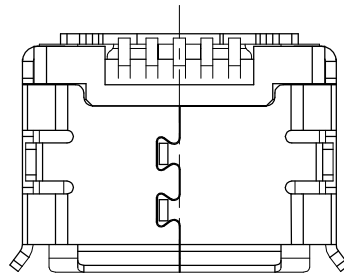
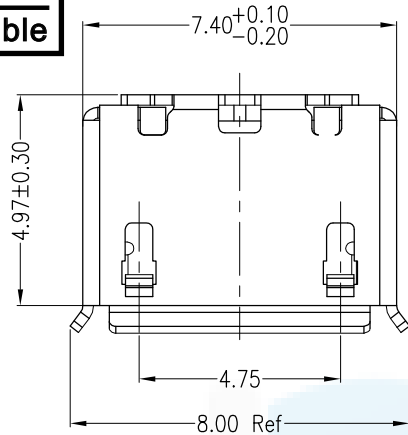
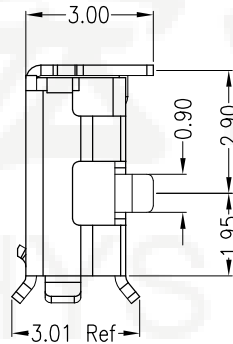
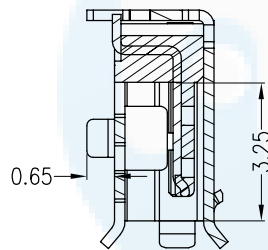

Note:

1.Material:

- 1.1 Housing: LCP High temperature thermoplastic with g.f,UL94v-0
- 1.2 Contact: copper alloy,t=0.20mm
- 1.3 Shell: SUS304,t=0.25mm

2.Specification:

- 2.1 Current rating:1,5PIN 1.8A Max/2,3,4PIN 1A Max.
- 2.2 Dielectric withstanding voltage: 100 V(ac) for 1 min.
- 2.3 Contact resistance: 30 mΩ Max.
- 2.4 Insulation resistance: 100 MΩ Min.
- 2.5 Total mating force: 3.57 Kgf Max.
- 2.6 Total unmating force: 1.0 Kgf Min.
- 2.7 Temperature range: -30°C~80°C

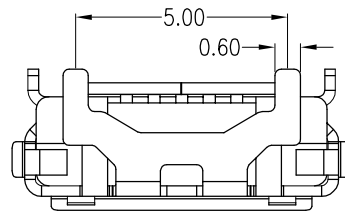
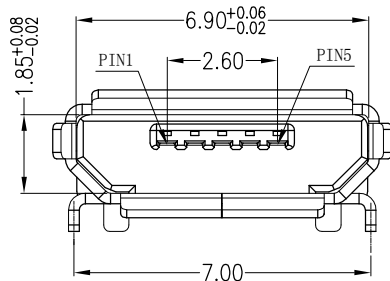

DESIGN	Li Jinwei	SCALL	
DRAWING	Wu Qifa	UNIT	mm
CHECK	Zheng Jinxian	SIZE	A4: 210 * 297
APPROVAL	Liu Xiaohong	DATE	2020-06-10

\varnothing	TOLERANCE
.x 0.15 .xxx 0.05	
.xx 0.10 Ang. 1°	

DRAWG NO.	USB-M-NJ05Q
TITLE:	牛角全插7.0 5.0无柱短针

 **东莞市宏煜盛实业有限公司**
Dongguan hongyusheng Industry Co., Ltd
TEL: 0769-81230179 <https://www.hystypec.com>