

ROHS
Compatible

NOTES:

SPECIFICATION:

1. CURRENT RATING: 3.0A MAX.
2. VOLTAGE: 100 VAC
3. TEMPERATURE RANGE: -30 °C ~ 85 °C
4. CONTACT RESISTANCE: 40 MILLIONHM MAX.
5. INSULATION RESISTANCE: 100 MEGOHMS MIN.
6. INSERTION FORCE : 5N~20N
7. UNMATING FORCE: 8N~20N
8. DURABILITY: 10 000 CYCLES

U5 161- 24P x 11.1L
↓ ↓ ↓ ↓ ↓ ↓
名称 流水号 PIN位 E;公头 L;长度

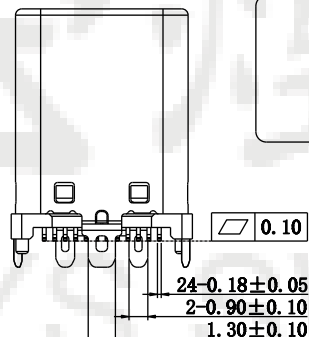
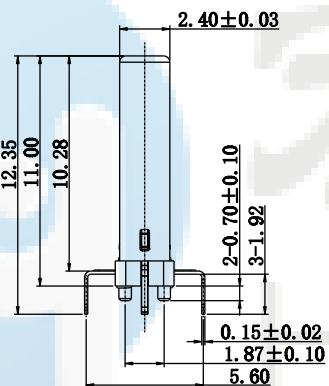
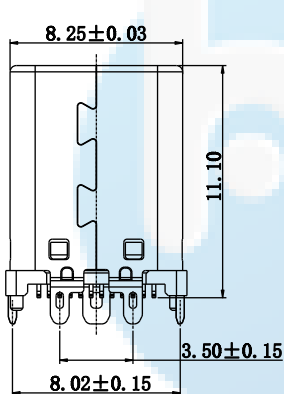
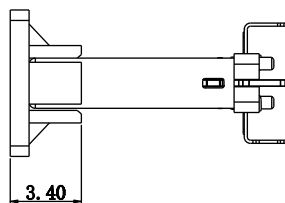
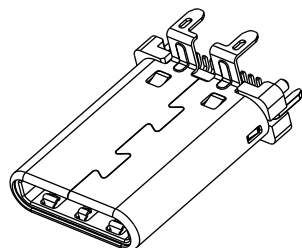
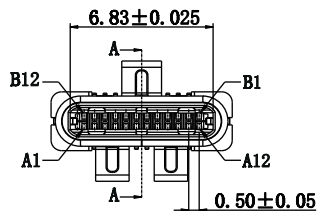

Added suction cap view
SCALE 1:1

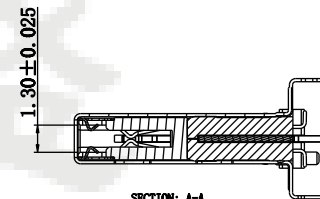
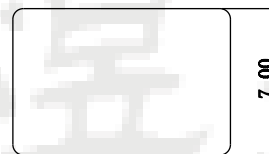

SECTION: A-A
SCALE 1:1

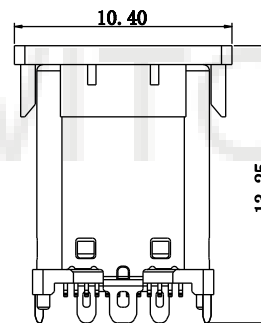

A1	GND	B12	GND
A2	SSTXP1	B11	SSRXP1
A3	SSTXN1	B10	SSRXN1
A4	VBUS	B9	VBUS
A5	CC1	B8	SBU2
A6	DP1	B7	DN2
A7	DN1	B6	DP2
A8	SBU1	B5	CC2
A9	VBUS	B4	VBUS
A10	SSRXN2	B3	SSTXN2
A11	SSRXP2	B2	SSTXP2
A12	GND	B1	GND
PIN	SIGNAL NAME	PIN	SIGNAL NAME

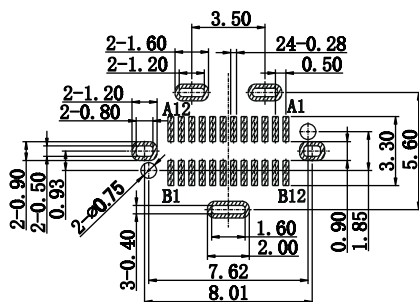
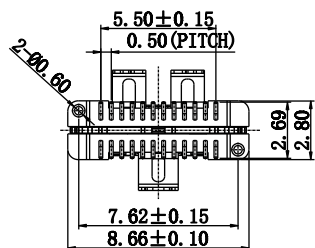

RECOMMENDED PCB LAYOUT (±0.08±0.05)
COMPONENT SIDE (GENERAL TOLERANCE: ±0.10)

NO.	DESCRIPTION	MATERIAL	REMARKS	Q'TY
6	HOUSING	HIGH TEMPERATURE PLASTIC, PA6T	BLACK	1PCS
5	CAP	HIGH TEMPERATURE PLASTIC, LCP	BLACK	1PCS
4	EMI	STAINLESS STEEL, SUS304	---	2PCS
3	LATCH	STAINLESS STEEL, SUS301	TIN: 80-120u"Min. /Ni base: 50u"Min. Plated	1PCS
2	SHELL	STAINLESS STEEL, SUS304	Ni: 50u"Min. Plated	1PCS
1	INSERT MOLDING	HIGH TEMPERATURE PLASTIC (HOUSING, LCP; TERMINAL, C5101)	CONTACT: Au: 3u"Min. Ni base: 50u"Min. BLACK	2PCS

DESIGN	Li Jinwei	SCALL	
DRAWING	Wu Qifa	UNIT	mm
CHECK	Zheng Jinxian	SIZE	A4: 210 * 297
APPROVAL	Liu Xiaohong	DATE	2020-06-10

TOLERANCE	
X.X ±0.30	X.°±2°
.XX ±0.20	.X°±1°
.XXX ±0.10	.XX°±0.5°

DRAWG NO.	U5161-24PE11.1L
TITLE:	公头24P 立式3脚插板SMT 11.1L

东莞市宏煜盛实业有限公司
Dongguan hongyusheng Industry Co., Ltd
TEL: 0769-81230179 <https://www.hystypec.com>

ROHS
Compatible

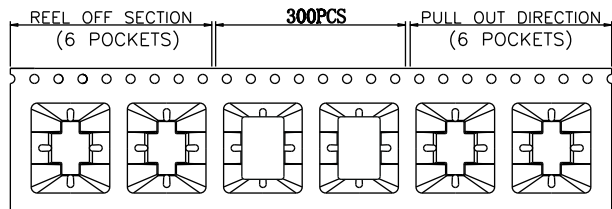

① 产品入载带示意图

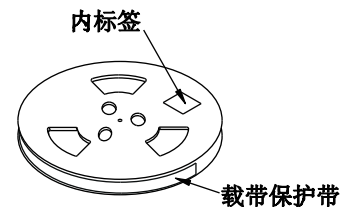

② 卷盘贴标签示意图

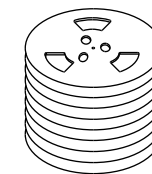

③ 11盘产品叠层示意图

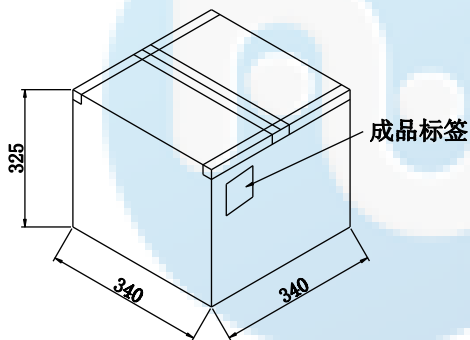

⑤ 外箱封箱示意图

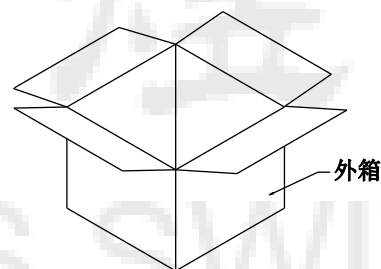

④ 产品入外箱示意图

包装说明:

1. 将检验好的成品;SMT朝下放入载带底部;每卷装300PCS产品;具体如图一所示
2. 将包装好的产品;每盘必需贴上内标签;具体如图二所示
3. 将贴好内标签的产品每11盘叠;具体如图三所示
4. 装好后并封好纸箱及贴好相关标签;具体如图五所示;
(产品包装的标签,如客户有要求,请按客户要求包装出货)
5. 载带前面留6PCS空格,后面留6PCS空格
6. COVER与CARRY剥离力:50-125g,速度:300mm/分钟左右,
剥离角度:165°-180°

	REEL	CARTON
CONNECTOR (PCS)	300	3300

DESIGN	Li Jinwei	SCALL		 TOLERANCE X.X ±0.30 X.°±2° .XX ±0.20 .X°±1° .XXX ±0.10 .XX°±0.5°
DRAWING	Wu Qifa	UNIT	mm	
CHECK	Zheng Jinxian	SIZE	A4: 210 * 297	
APPROVAL	Liu Xiaohong	DATE	2020-06-10	

DRAWG NO.	U5161-24PE11.1L
TITLE:	公头24P 立式3脚插板SMT 11.1L



东莞市宏煜盛实业有限公司
Dongguan hongyusheng Industry Co., Ltd
TEL: 0769-81230179 <https://www.hystypec.com>