

ROHS
Compatible

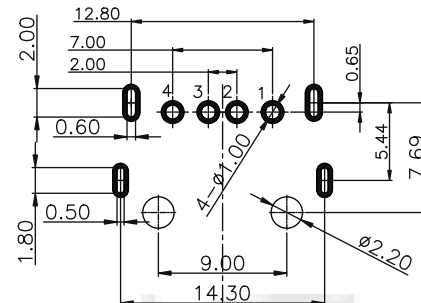
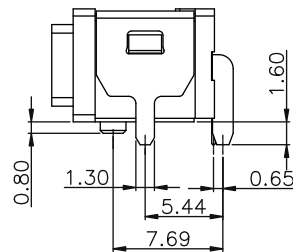
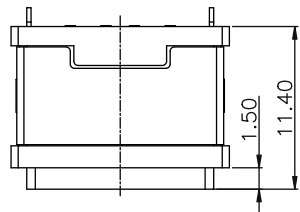

RECOMMENDED PCB LAYOUT(TOP VIEW)

THICKNESS T=1.0mm
DEFAULT TOLERANCE+/-0.05

NOTES:
SPECIFICATION:

1. CURRENT RATING: 3.0A MAX
2. DIELECTRIC WITHSTAND VOLTAGE: 100VAC
3. TEMPERATURE RANGE: -30 °C ~ 85 °C
4. CONTACT RESISTANCE: 40 MILLIONHM MAX
5. INSULATION RESISTANCE: 100 MEGOHMS MIN.
6. INSERTION FORCE :10N~30N
7. UNMATING FORCE: 8N~30N
8. DURABILITY:1500 CYCLES

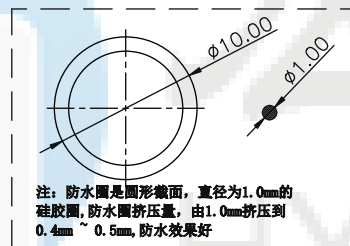
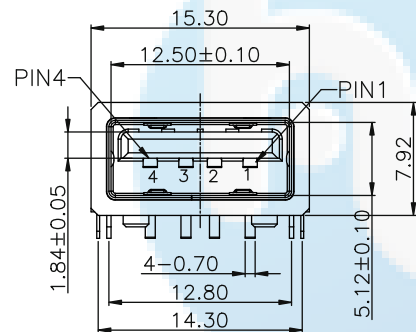
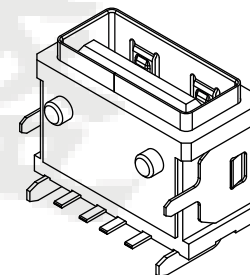

注: 防水圈是圆形端面, 直径为1.0mm的硅胶圈, 防水圈挤压量, 由1.0mm挤压到0.4mm ~ 0.5mm, 防水效果好

结构设计注意:

1. 成品使用时, 如有洗面奶泡沫、牙膏、洗手液、脏污液体, 请在USB口外面再设计一层外壳, 保护USB与公头对插的导电部份不会被脏污覆盖。

PIN ASSIGNMENT

PIN NO.	1	2	3	4
SINGAL NAME	VBUS	D-	D+	GND

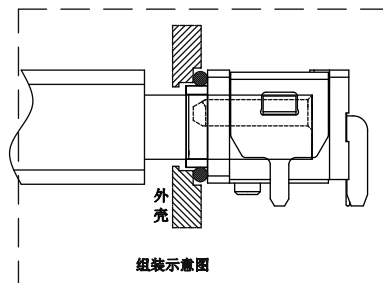
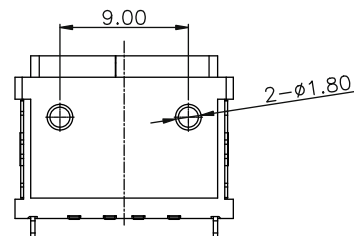
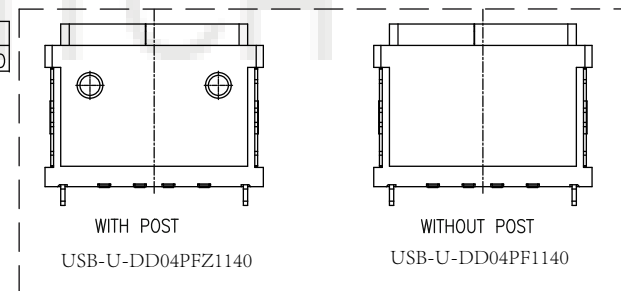

ITEM	PART NAME	Q' TY	FINISH	NOTE
5	Outer Shell	1	SUS 301 1/4H	
4	Inner Shell	1	SUS 301 1/4H	
3	PLASTIC Shell	1	PA10T (G.F30%)	
2	Contact	4	BRASS C2680-EH Au/Ni Plating T=0.25mm	
1	Housing	1	PA10T (G.F30%)	

DESIGN	Li Jinwei	SCALL		TOLERANCE	
DRAWING	Wu Qifa	UNIT	mm	X.X ±0.30	X.°±2°
CHECK	Zheng Jinxian	SIZE	A4: 210 * 297	.XX ±0.20	.X° ±1°
APPROVAL	Liu Xiaohong	DATE	2020-06-10	.XXX ±0.10	.XX° ±0.5°

DRAWG NO.	USB-U-DD04PFZ1140
TITLE:	防水USB2.0 板上四脚插板DIP 带柱 11.4L IPX7



东莞市宏煜盛实业有限公司
Dongguan hongyusheng Industry Co., Ltd
TEL: 0769-81230179 <https://www.hystypec.com>