

ROHS
Compatible

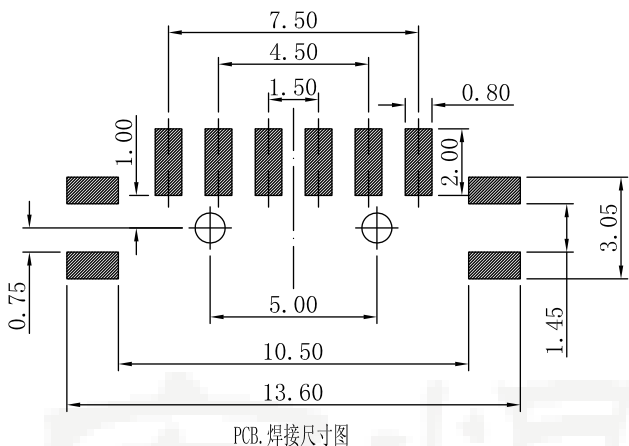

PCB. 焊接尺寸图

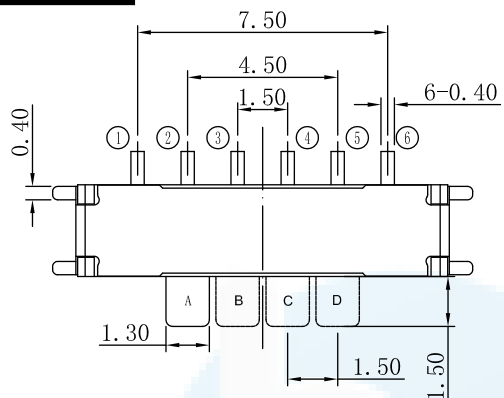
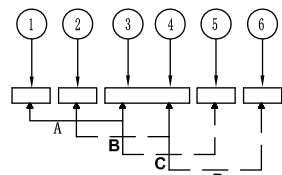

电路图

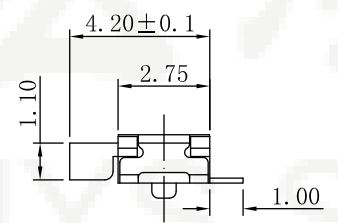
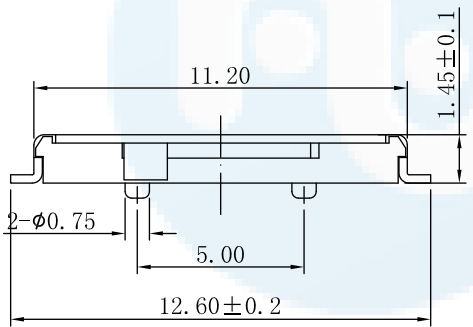

| 项 目 | | 标 准 |
|------|-----------------------------|-------------------|
| 电气性能 | 额定电流 Rated Current: | 50mA |
| | 额定电压 Rated voltage: | DC12V |
| | 接触电阻 Contact resistance: | ≤70mΩ |
| | 绝缘电阻 Insulation Resistance: | ≥100MΩ |
| | 耐压强度 Compressive strength: | AC250V 50Hz/1min |
| 机械性能 | 操作力度 Operating force: | 180±50gf |
| | 机械寿命 Mechanical life: | 10,000 cycles Min |
| | 操作行程 Operation Stroke: | 1.50±0.2mm |
| 环境性能 | 温度范围 Temperature Range: | -25° C TO +70° C |

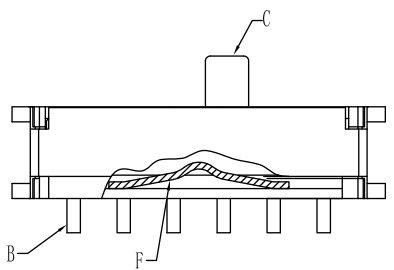
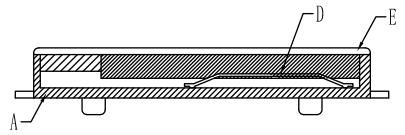

| NO. | 零件名称 Part Name | QTY | 材料 Material | 镀涂 Plating coating | 颜色 colour |
|-----|----------------|-----|-------------|--------------------|-----------|
| F | 弹条 | 1 | 不锈钢 | 整体清洗 | 本色 |
| E | 盖板 | 1 | 磷铜 | 镀银 | 银白色 |
| D | 簧片 | 1 | 铍青铜 | 镀银 | 银白色 |
| C | 手柄 | 1 | PPA | / | 黑色 |
| B | 端子 | 1 | 磷铜 | 整体镀银 | 银白色 |
| A | 底座 | 1 | LCP | / | 黑色 |

| | | | |
|----------|---------------|-------|---------------|
| DESIGN | Li Jinwei | SCALL | |
| DRAWING | Wu Qifa | UNIT | mm |
| CHECK | Zheng Jinxian | SIZE | A4: 210 * 297 |
| APPROVAL | Liu Xiaohong | DATE | 2020-06-10 |

| | |
|------------|-----------|
| TOLERANCE | |
| X.X ±0.30 | X.°±2° |
| .XX ±0.20 | .X°±1° |
| .XXX ±0.10 | .XX°±0.5° |

| | |
|-----------|---------------|
| DRAWG NO. | HYS-236 |
| TITLE: | 拨动开关 十脚四档卧式贴片 |

东莞市宏煜盛实业有限公司
 Dongguan hongyusheng Industry Co., Ltd
 TEL: 0769-81230179 <https://www.hystypec.com>